



U T O P I A P L A N I T I A

THE CORE INSTRUCTION MANUAL



WARNING

IMPORTANT PLEASE READ

The Core is a power adapter that allows you to use your Up Tech vaporizers to its fullest potential. If not used properly it will damage cartridges and or pose risk of personal injury not limited to personal property.



Just because you know how to operate a device of this type does not mean you know how to operate this device. Read the manual. Choosing not to read the manual will only cause you further grief and or loss of valuable time. This is not a toy and not following the directions and ranges will cause problems.



Before you continue please read the voltage ranges that we have recommended in the next page. READ IT!!! Do not skim it, as it will cause more problems and possible injury and damage to your personal property.

Warning we are not responsible for any burnt out cartridges that may be caused by The Core. We recommend that you use the least amount of power as possible to help increase the life of your cartridges.



Warning we are not responsible for any injury or damage The Core may cause. Using it is at your own risk.





VAPORIZER VOLTAGE RANGES

PERSEI VAPORIZER 7.4V

Maximum set voltage = 7.5v when using the Hercules 7.4v version, Bender and or Hammer attachments, 6.4v – 7.6v. When using 5.0 ohm cartridges please understand that the higher the voltage set will decrease cartridge life.

OMICRON NONE HVD UNITS.

Maximum set voltage = 4.2v

Minimum set voltage = 3.3v

OMICRON HVD UNITS

Maximum set voltage = 7.5v when using the Hercules 7.4v version, Bender and or Hammer attachments, 6.4v – 7.6v. When using 5.0 ohm cartridges please understand that the higher the voltage set will decrease cartridge life.

MINICRON HVD UNIT

Maximum set voltage = 7.5v when using the Hercules 7.4v version, Bender and or Hammer attachments, 6.4v – 7.6v. When using 5.0 ohm cartridges please understand that the higher the voltage set will decrease cartridge life.

Warning Voltages between 5.4v and 6.3v are not available on the Persei and Omicron HVD Vaporizers due to a conflict in the Low Battery Voltage circuitry.

Warning we are not responsible for any burnt out cartridges that may be caused by The Core. We recommend that you use the least amount of power as possible to help increase the life of your cartridges.





ATTACHMENT VOLTAGE RANGES

HERCULES SR 71 - 7.4V VERSION

Maximum set voltage = 7.5v

Minimum set voltage = 6.4v

HERCULES SR 71 - 3.7V VERSION

Maximum set voltage = 4.0v

Minimum set voltage = 3.4v

BENDER GLASS CHAMBER

Maximum set voltage = 7.5v

Minimum set voltage = 6.4v

HAMMER NAIL ATTACHMENT

Maximum set voltage = 7.5v

Minimum set voltage = 6.4v

		● Good To Go	Battery Volts (V)			● Don't Do It!
			3.7-4.2	4.3-5.2	5.3-6.2	6.3-7.4*
Cartridges (Ω)	1.5	● *	●	●	●	* Will heat up faster and provide bigger vapor, for experienced users only
	2.4	● **	● *	●	●	
	3.0	● ***	● **	● **	●	
	4.0	●	● ***	● **	●	*** Will heat slower, provide lighter vapor, for the user who can't inhale too much at one time
	5.0	●	●	● ***	● **	

Warning we are not responsible for any burnt out cartridges that may be caused by The Core. We recommend that you use the least amount of power as possible to help increase the life of your cartridges.





OVERVIEW

The Core power supply is designed to provide constant voltage for a wide range of Up Tech Vaporizers including the following:

O-Phos, Omicron Lite, Minicron, Omicron v2.xx and Persei vaporizers and attachments including following Original Cartridges, Kiss Cartridges, Hammer, Bender, Hercules and Hercules SR 71.

SPECIFICATIONS

Input Voltage:	110-240 VAC 50-60Hz - 12 VDC
Output Voltage:	Adjustable from 3.0-8.4v
Increments of:	0.1v +/-
Output Power:	40w or 5 amps
Output Jack:	2.5mm Barrel Connector





SETUP

This section describes how to set up and connect your Core to your Up Tech Vaporizer.



Step 1.

Remove the battery tube from your vaporizer along with the batteries and replace it with the Core Battery Pack.

Step 2.

Plug the Core connector into the jack at the bottom of the Core battery pack.

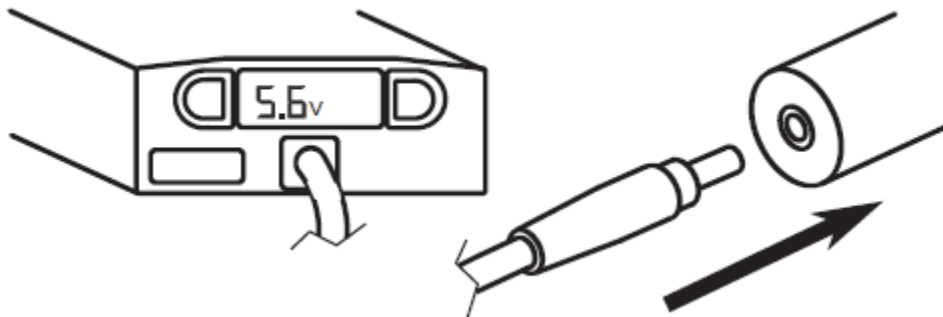



SETUP

Step 3. Attach the AC Cord or the Car Adapter to the power input on the Core power supply.

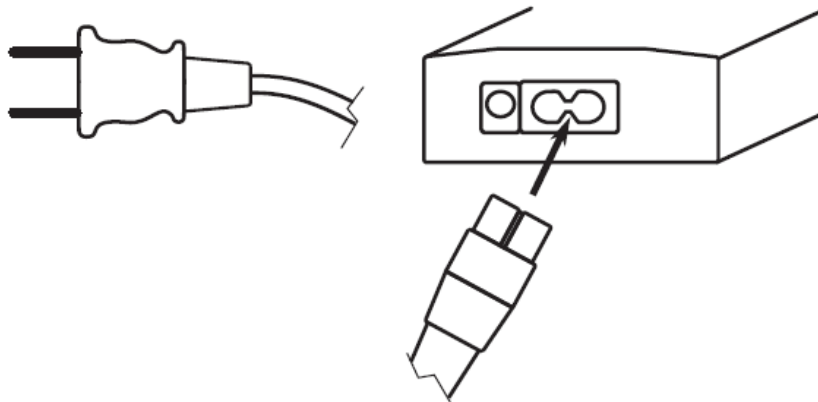

OR

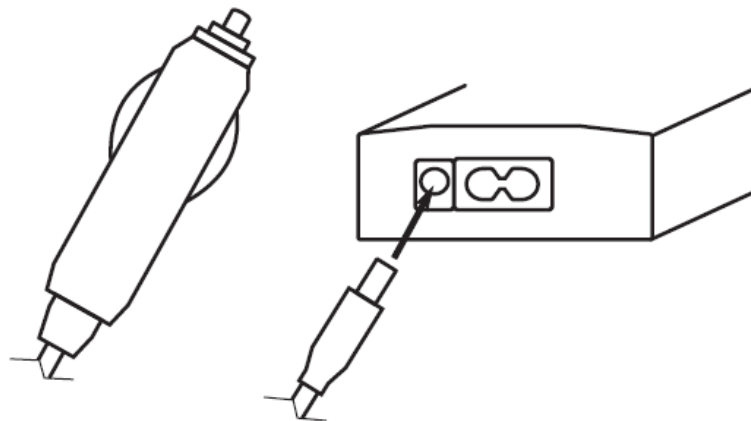



OPERATION

Step 1) Plug The Core in.

When the Core is plugged into household current or into an energized car lighter jack, the Core will automatically turn on and displace the last voltage it was set to.

Step 2) Select the Voltage within 5 seconds of turning it on and you are able to adjust the voltage up or down.

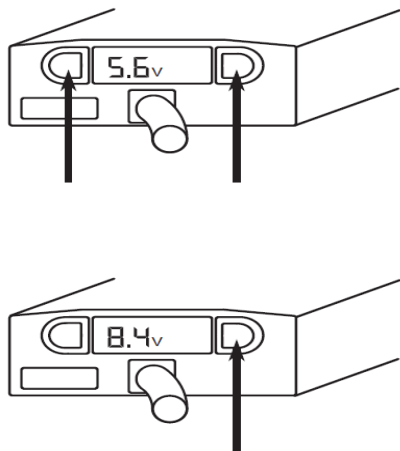

REMINDER

In case you are not able to adjust within the allowed time just press both the +/- buttons at the same time to unlock it then use the +/- buttons to adjust.

Once the voltage reaches 8.4 volts, pressing the + button again will cause the voltage to roll over to 3.0 volts.





OPERATION (CONTINUED)

REMINDER

In case you are not able to adjust within the initial 5 seconds just press both +/- buttons at the same time to enter voltage adjustment mode.

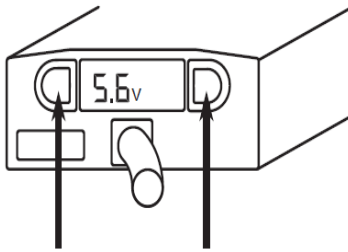

Adjusting your Voltage.

Press + to increase your voltage.

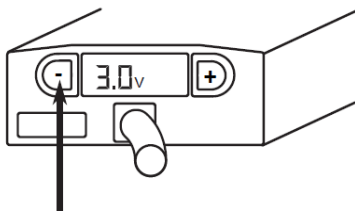
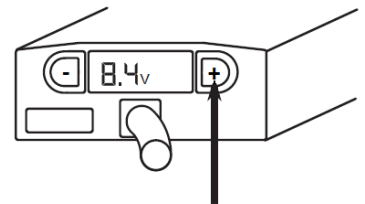

Press – to decrease your voltage.

If no buttons are pressed during any 5 second window, the Core will automatically exit the programming mode. Pressing either a LEFT - or RIGHT + button by itself will no longer change the voltage.





TROUBLESHOOTING

<p>No Power when using the Core with the 110v or a 12v adapter</p>	<p>Make sure your power outlet or car jack is energized. You might need to rest a fuse, consult with your electrician or your land lord. Some cars need to have their key turned on to energize the car accessory port.</p> <p>Check that the cables have no damage on them and are properly plugged in.</p>
<p>Pressing + or - buttons does not change voltage or [-] is displayed.</p>	<p>Make sure the Core is in the voltage programming mode, Press the + and - buttons at the same time to enter the programming mode. Once in the programming mode, you must press either the LEFT or the RIGHT button within 5 seconds or the Core will automatically exit the programming mode.</p>
<p>The displayed voltage drops when using my vaporizer</p>	<p>The automatic over-current protection circuit has turned on. You are trying to draw more than 40 watts or 5 amps. Either decrease the voltage or use a cartridge that has a higher resistance (more Ohms).</p>

www.w9tech.com

